



Product & Training Manual

Canister Vacuum Cleaner - Glide and Hush



pacvac.com

Product & Training Manual

Canister Vacuum Cleaner

Contents

Product & Training Manual	2
Symbol Definitions	3
General Safety Instructions	4
Product Specific Safety Instructions.....	5
Specifications	5
Operating Instructions	6
Safe Disposal	6
Safety and Maintenance Checks	7
Troubleshooting	8
Warranty	9
Service Requirements.....	9
Spare Parts	10
Warranty Notes.....	11

CAUTION Read this Product & Training Manual before using the machine and instruct operators if applicable.
RETAIN FOR FUTURE REFERENCE.

This manual applies to the Canister Series: Glide and Hush commercial vacuum cleaners

Symbol Definitions

1. Attention!



2. Operator's Manual; Operating Instructions



General Safety Instructions

WARNING To reduce the risk of fire, electric shock or injury, read all instructions before using. When using an electrical appliance, basic precautions should always be followed.

1. This manual shall be considered an integral part of the machine and should be carefully looked after for subsequent reference.
2. **WARNING** Operators shall be adequately instructed on the use of this machine.
3. **WARNING** This machine is not suitable for picking up hazardous dust.
4. **WARNING** Do not use this machine in wet conditions.
5. **WARNING** Do not allow the power cord to come into contact with rotating brushes of floor tools.
6. **CAUTION** This machine is for indoor use only.
7. **CAUTION** This machine shall be stored indoors only.
8. Remove the machine from packaging and ensure it and all its accessories and attachments are present and in perfect condition. Contact the place of purchase immediately in the event of any discrepancies.
9. The electrical specifications of this machine are noted on the data plate which is located near the power switch. Ensure the specifications correspond to those of the mains power supply in your area. If the machine is without a data plate, contact the place of purchase immediately.
10. This machine is intended for commercial use, for example in hotels, schools, hospitals, factories, shops or offices.
11. Do not restrict the vacuum cleaner's airflow. Maintain the vacuum cleaner regularly so that all filters and openings are free of dust, lint, hair build-up or anything else which may affect airflow. Refer to the maintenance instructions in this Product and Training Manual.
12. If the machine has been dropped, damaged, left outdoors or has been exposed to liquids, return it to your local Authorised Pacvac Service and Warranty Agent for a safety check.
13. Do not use the machine to pick up flammable or combustible liquids, such as petrol etc. and do not use in areas where they may be present.
14. Do not vacuum anything that is burning or smoking such as cigarettes or hot ashes.
15. Do not vacuum up hard or sharp objects (glass, nails, screws etc).
16. Keep hair, loose clothing, fingers and all parts of the body away from moving parts and openings.
17. Keep the machine and power cord away from heated surfaces.
18. Do not unplug the machine while it is turned on. Turn the machine OFF, turn the power off at the power outlet then unplug by grasping the plug and pulling gently to unplug.
19. Do not handle the machine, power cord or plug with wet hands.
20. Unplug from power point when not in use, before servicing or before changing filters.
21. Do not pull or carry the machine by the power cord.
22. Do not close doors on the power cord and do not pull the cord around sharp edges or corners.
23. Regularly check the power cord for damage, such as cuts, abrasions, exposed wiring or aging. If the power cord or plug is damaged, the complete power cord must be replaced by your local Authorised Pacvac Service and Warranty Agent in order to avoid an electric shock. The power cord should only be replaced with a Pacvac Genuine Spare Part with the same specifications.
24. Store in an appropriate place after use to prevent tripping accidents.
25. This appliance is not intended for use by persons (including children) with reduced physical, sensory or mental capabilities, or lack of experience and knowledge, unless they have been given supervision or instruction concerning use of the machine by a person responsible for their safety. Children should be supervised to ensure that they do not play with this machine.
26. Use only the manufacturer's recommended attachments and/or replacement parts.

Product Specific Safety Instructions

1. **WARNING** This machine is intended for the vacuuming of dry dust and/or small debris off dry carpeted or hard floor surfaces in indoor areas only.
2. **WARNING** Do not use the machine without the dust bag and filters in place.
3. **CAUTION** Take extra care if using this vacuum cleaner to vacuum stairs.
4. The following models have a "A"-weighted emission sound pressure level (at ear) of:
Glide - $78.9 \pm 3\text{dB(A)}$
Hush - $78 \pm 3\text{dB(A)}$ / $74.4 \pm 3\text{dB(A)}$ *hush mode*
5. Below are the floor tool and attachments recommended use

Motor Thermostat

IMPORTANT: The motor is equipped with a thermostat. If for any reason, the vacuum cleaner should over-heat, the thermostat will automatically turn the unit off. Should this occur, turn off the switch and unplug the vacuum cleaner from the electrical outlet and conduct safety and maintenance checks. Allow the cleaner to cool for approximately 30 minutes. To re-start, plug into a power point and switch back on.

Part No.	Recommended use
FLT001	Floor Tool is intended for vacuuming of dry dust and debris off floor surfaces.
ACC001	Dusting Brush is intended for vacuuming of dry dust from blinds and other delicate surfaces.
ACC002	Crevice Tool is intended for vacuuming of dry dust from crevices.
ACC003	Upholstery Tool is intended for vacuuming of dry dust from upholstered surfaces.

RETAIN THESE SAFETY INSTRUCTIONS FOR FUTURE USE.

Specifications

Model Name	Glide	Hush
Model No.	01GL001VC	01HU001VC
Motor	1300W single-stage flow through	1300W single-stage flow through
Noise Level (at 1.5m)	78.9dB(A)	<78dBA
Filtration	3 stage	3 stage; H13 HEPA filter (pre-motor)
Volumetric Airflow (Max.)	33.9L/s	35.7L/s, 25.3L/s (hush mode)
Capacity	15L	15L
Weight	5kg (ex. power cord assembly & hose assembly)	5.1kg (ex. power cord assembly & hose assembly)
Power Source	Mains, 18m cord, hardwired	Mains, 18m cord, hardwired

*Technical specifications are subject to change without notice.

Operating Instructions

1. Stand upright, with the bent hand piece section parallel to the floor.
2. Hold the bent hand piece with one hand at a comfortable arm's length. Use your free hand to hold the hose to help guide the vacuum as you work.
3. Move forward and away from the power point.
4. Use easy underarm swinging motion when detail cleaning and short dabs when spot cleaning, always standing upright.
5. Once the end of the power cord has been reached and work completed, switch mains off, return to the power point along the cord line and disconnect the power cord from the power point.
6. If work is not completed and you need to move to another area, switch mains off, disconnect the power cord, move toward desired area, connect power cord to the nearest power point and repeat steps 1 through 6.
7. If work is completed disconnect power cord from power point then wind from the canister towards the end of the power cord to reduce likelihood of cable twists. In the process check for nicks, cuts, fractures, and knots.

HI/LOW function (Hush only)

With your machine switched on, you can choose between modes using the hi/low switch. HI = standard; LOW = hush (reduced noise).

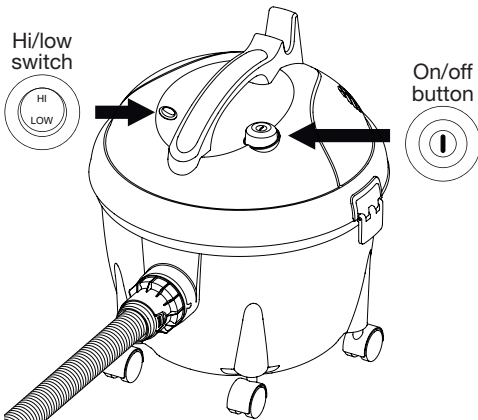

Storage

For better storage, the wand connects to the back of the machine with a hook.

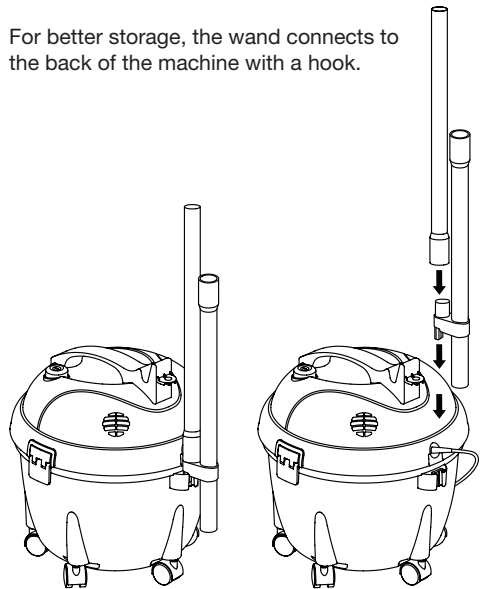

Safe Disposal

Contact your local waste authority for information regarding available recycling and/or disposal options. Or contact Pacvac by emailing support@pacvac.com or phone +61 8 9479 1444 for the latest information.

Europe Only - When replacing old appliances with new ones, please check if the retailer is legally obligated to take back your old appliance for disposal.

Safety and Maintenance Checks

Daily routine check

1. Remove and clean or replace the dust bag.

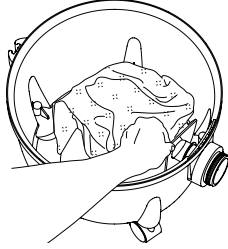

2. Slide off sealing clip to open and empty the dust bag. Replace sealing clip before reinstalling the dust bag.

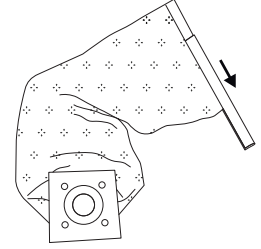

3. Turn cuff or pre-motor filter in a clockwise direction to unlock. Remove and tap gently to clean motor filter or pre-motor filter.

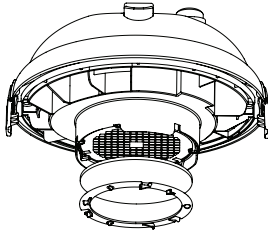

4. Check all power cords, for cuts, abrasions and exposed wiring.

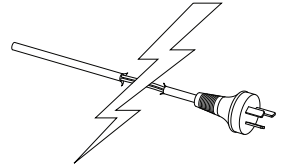

5. Wind up power cord from machine end. Store power cord as shown.

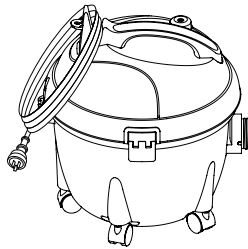

6. Check the floor tool, wand, bent handpiece and hose for any obstructions.

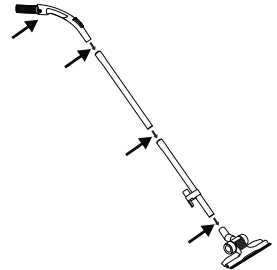

WEEKLY

Remove and clean the external motor filter.

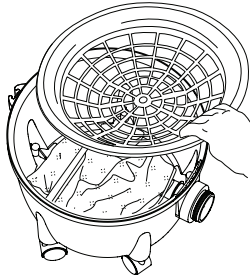

NOTE: Any other servicing should be performed by an Authorised Service & Warranty Agent.

Troubleshooting

Caution: Always unplug the backpack before attempting to solve a problem or when servicing.

Problem	Cause	Solution
Vacuum cleaner not working	Power cord not firmly plugged into power point.	Plug power cord into power point firmly.
	Vacuum cleaner not turned on.	Press on/off button.
	Thermal protector shuts off vacuum cleaner due to high motor temperature.	Turn main switch off and unplug the vacuum cleaner. Conduct safety and maintenance checks found in this Product and Training Manual. After 30 minutes the vacuum cleaner should be ready for use. If not contact Pacvac for your nearest Authorised Pacvac Service and Warranty Agent.
	Circuit breaker or RCD has tripped.	Check the machine is in good working order. If OK, reset circuit breaker or RCD. If circuit breaker or RCD trips again contact your nearest Authorised Pacvac Service and Warranty Agent.
Vacuum cleaner has no/poor suction	Dust bag full.	Remove, empty and clean dust bag.
	Dust bag not installed correctly.	Remove and empty dust bag making sure the rubber seal is fitted correctly.
	Hose not installed correctly.	Reconnect hose and ensure correctly sealed.
	Blockages.	Remove hose, wand and floor tools; remove any blockages.
	Filters blocked.	Clean filters.
	Filter not installed correctly.	Refit filter making sure the rubber edging is correctly fitted around the filter retainer.

Warranty

Your Pacvac Pty Ltd (Pacvac) product has been manufactured to meet our highest quality standards. We urge you to take good care of your product and be sure to follow instructions carefully. This will provide you with the best possible performance and lifespan of the product.

The inclusion of the following paragraph is a requirement by Australian Law. It explains that consumers have rights by law regardless of any warranties provided or not by a manufacturer or supplier.

“Our goods come with guarantees that cannot be excluded under the Australian Consumer Law. You are entitled to a replacement or refund for a major failure and for compensation for any other reasonably foreseeable loss or damage. You are also entitled to have the goods repaired or replaced if the goods fail to be of acceptable quality and the failure does not amount to a major failure.”

In addition to the guarantees under Australian Consumer Law, Pacvac warrants all machines and their components against faulty material and / or workmanship for a period of two years from the date of purchase by the original consumer.

The following explains conditions and what to do in the event of a claim:

Pacvac will replace parts determined as faulty however this does not cover reasonable wear through normal use of any consumable parts, such as but not limited to, bags, filters, hoses, electrical leads, carbon brushes and floor tools etc.

Warranty does not cover any machine or component that has been altered, abused, neglected, modified, used with non-genuine Pacvac components or has not been used and maintained as indicated in this Product & Training Manual.

Warranty repairs can only be carried out by an Authorised Pacvac Distributor or Repairer. Visit our website for your nearest location. Warranty claims are limited to the original warranty period from the date of purchase. Warranty repairs and / or replacements do not extend the original warranty period.

All reasonable expenses associated with returning goods for a warranty claim are the consumer's responsibility.

Claims must be made within two years of the date of purchase and proof of purchase must be supplied with the claim.

To make a claim under warranty, take the product with proof of purchase to the place of purchase. If the place of purchase does not satisfactorily rectify the matter, please contact Pacvac.

Pacvac has the right to request pictures of warranty product failures or to request for those parts be returned to Pacvac's office in Western Australia.

The replacement of any part shall be at Pacvac's discretion.

 +61 8 9479 1444  support@pacvac.com  pacvac.com

Service Requirements

Our products are designed and built to be functional and durable. For information on use and maintenance please read this Product & Training Manual thoroughly.

Should you require servicing contact your nearest Authorised Pacvac Service and Warranty Agent.

Spare Parts

Quote these part numbers when ordering spare parts.

No.	Part Name	Part No.
1.	Dusting brush 32mm	ACC001
2.	Crevice tool 32mm	ACC002
3.	Upholstery tool 32mm	ACC003
4.	Cord restraint	COR004
5.	Handle cover 220mm	COV001
6.	Top cover 380mm	COV002
7.	Disposable sealed paper dust bag 15L (10pk)	DUB031
8.	Reusable sealed SMS dust bag 15L (grey)	DUB009
9.	H13 HEPA Pre-motor cartridge filter 33mm (Hush and Government only)	FIL032
10.	Synthetic filter cover	FIL008
11.	All purpose floor tool 285mm	FLT001
12.	Plastic handle 280mm	HAN002
13.	Screw fit hose 2m	HOA013
14.	Wand hook 32mm	HOK001
15.	Plastic latch 50mm	LAT002
16.	Chrome two piece wand	WND002

*Technical specifications, part numbers and parts designs are subject to change without notice.

Spare Parts

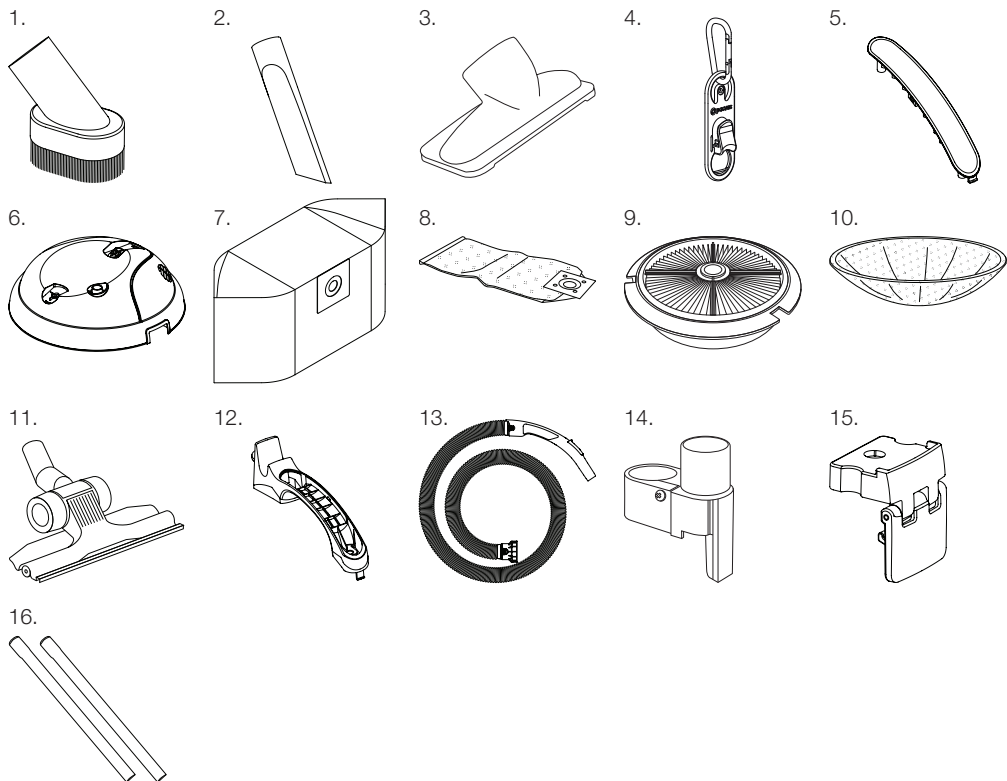

Online Manual

Visit academy.pacvac.com or scan the QR code to access the online manual.



Revised: June 2023
MAN005-canister-series-manual-v01

Pacvac Pty Ltd
ABN: 60 709 396 593
7 Mackay Street, Kewdale WA 6105
AUSTRALIA

 +61 8 9479 1444  support@pacvac.com  pacvac.com